

ER-OLED0.96-1 Series

OLED Display Datasheet



EastRising Technology Co., Limited

Attention:

- A. Some specifications of IC are not listed in this datasheet. Please refer to the IC datasheet for more details.
- B. The related documents for interfacing, demo code, ic datasheet are all available, please download from www.buydisplay.com.
- C. Please pay more attention to "Quality Control" in this Datasheet. We assume you already agree with these criterions when you place an order with us. No more recommendations.

REV	DESCRIPTION	RELEASE DATE
1.0	Preliminary Release	Jul-31-2014
2.0	Part Number Update and Add New 0.96"OLED with Connector FPC	Jun-08-2015

ORDERING INFORMATION

Part Number(Order Number)	Description
ER-OLED0.96-1YB	Blue&Yellow 0.96"OLED Display with Soldering Type FPC
ER-OLED0.96-1B	Blue 0.96"OLED Display with Soldering Type FPC
ER-OLED0.96-1W	White 0.96"OLED Display with Soldering Type FPC
ER-OLED0.96-1.1YB	Blue&Yellow 0.96"OLED Display with Connector Type FPC Bottom Contact
ER-OLED0.96-1.1B	Blue 0.96"OLED Display with Connector Type FPC Bottom Contact
ER-OLED0.96-1.1W	White 0.96"OLED Display with Connector Type FPC Bottom Contact
ER-OLED0.96-1.3YB	Blue&Yellow 0.96"OLED Display with Connector Type FPC Top Contact
ER-OLED0.96-1.3B	Blue 0.96"OLED Display with Connector Type FPC Top Contact
ER-OLED0.96-1.3W	White 0.96"OLED Display with Connector Type FPC Top Contact
ER-DBO0.96-1	8051 Microcontroller Development Board&Kit for ER-OLED0.96-1YB, ER-OLED0.96-1B and ER-OLED0.96-1W
ER-DBO0.96-1.1	8051 Microcontroller Development Board&Kit for ER-OLED0.96-1.1YB,ER-OLED0.96-1.1B,ER-OLED0.96-1.1W ER-OLED0.96-1.3YB,ER-OLED0.96-3B.,ER-OLED0.96-1.3W

Image



↑ ER-OLED0.96-1YB



↑ ER-OLED0.96-1B



↑ ER-OLED0.96-1W



↑ ER-OLED0.96-1.1YB



↑ ER-OLED0.96-1.1B



↑ ER-OLED0.96-1.1W



↑ ER-OLED0.96-1.3YB



↑ ER-OLED0.96-1.3B



↑ ER-OLED0.96-1.3W

Contents

Revision History *i*

Notice *ii*

Contents *iii*

1. Basic Specifications **1~5**

 1.1 Display Specifications 1

 1.2 Mechanical Specifications 1

 1.3 Active Area & Pixel Construction 1

 1.4 Mechanical Drawing 2

 1.5 Pin Definition 3

 1.6 Block Diagram 5

 1.6.1 V_{CC} Supplied Externally 5

 1.6.2 V_{CC} Generated by Internal DC/DC Circuit 6

2. Absolute Maximum Ratings **7**

3. Optics & Electrical Characteristics **8~13**

 3.1 Optics Characteristics 8

 3.2 DC Characteristics 8

 3.3 AC Characteristics 9

 3.3.1 68XX-Series MPU Parallel Interface Timing Characteristics 9

 3.3.2 80XX-Series MPU Parallel Interface Timing Characteristics 10

 3.3.3 Serial Interface Timing Characteristics (4-wire SPI) 11

 3.3.4 Serial Interface Timing Characteristics (3-wire SPI) 12

 3.3.5 I²C Interface Timing Characteristics 13

4. Functional Specification **14~15**

 4.1 Commands 14

 4.2 Power down and Power up Sequence 14

 4.2.1 Power up Sequence 14

 4.2.2 Power down Sequence 14

 4.3 Reset Circuit 14

 4.4 Actual Application Example 15

5. Reliability **16**

 5.1 Contents of Reliability Tests 16

 5.2 Lifetime 16

 5.3 Failure Check Standard 16

6. Quality Control **17**

CONFIDENTIAL

1. Basic Specifications

1.1 Display Specifications

- 1) Display Mode: Passive Matrix
- 2) Drive Duty: 1/64 Duty

1.2 Mechanical Specifications

- 1) Outline Drawing: According to the annexed outline drawing
- 2) Number of Pixels: 128 × 64
- 3) Panel Size: 26.70 × 19.26 × 1.45 (mm)
- 4) Active Area: 21.744 × 10.864 (mm)
- 5) Pixel Pitch: 0.17 × 0.17 (mm)
- 6) Pixel Size: 0.154 × 0.154 (mm)
- 7) Weight: 1.54 (g)

1.3 Active Area & Pixel Construction

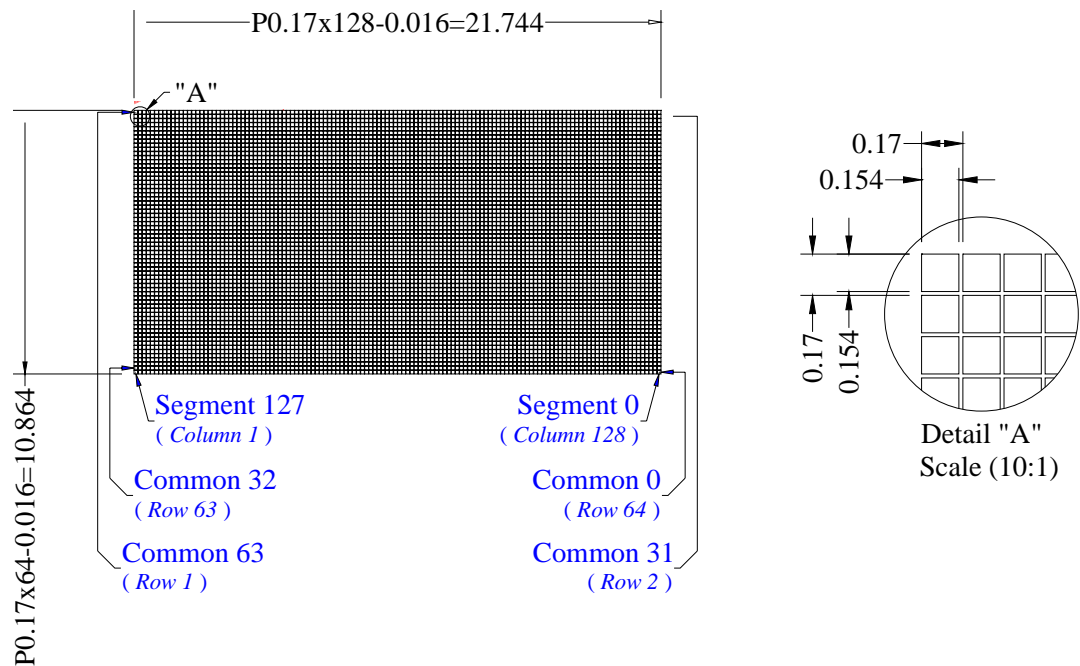

1.4 Mechanical Drawing (with Soldering Type FPC)

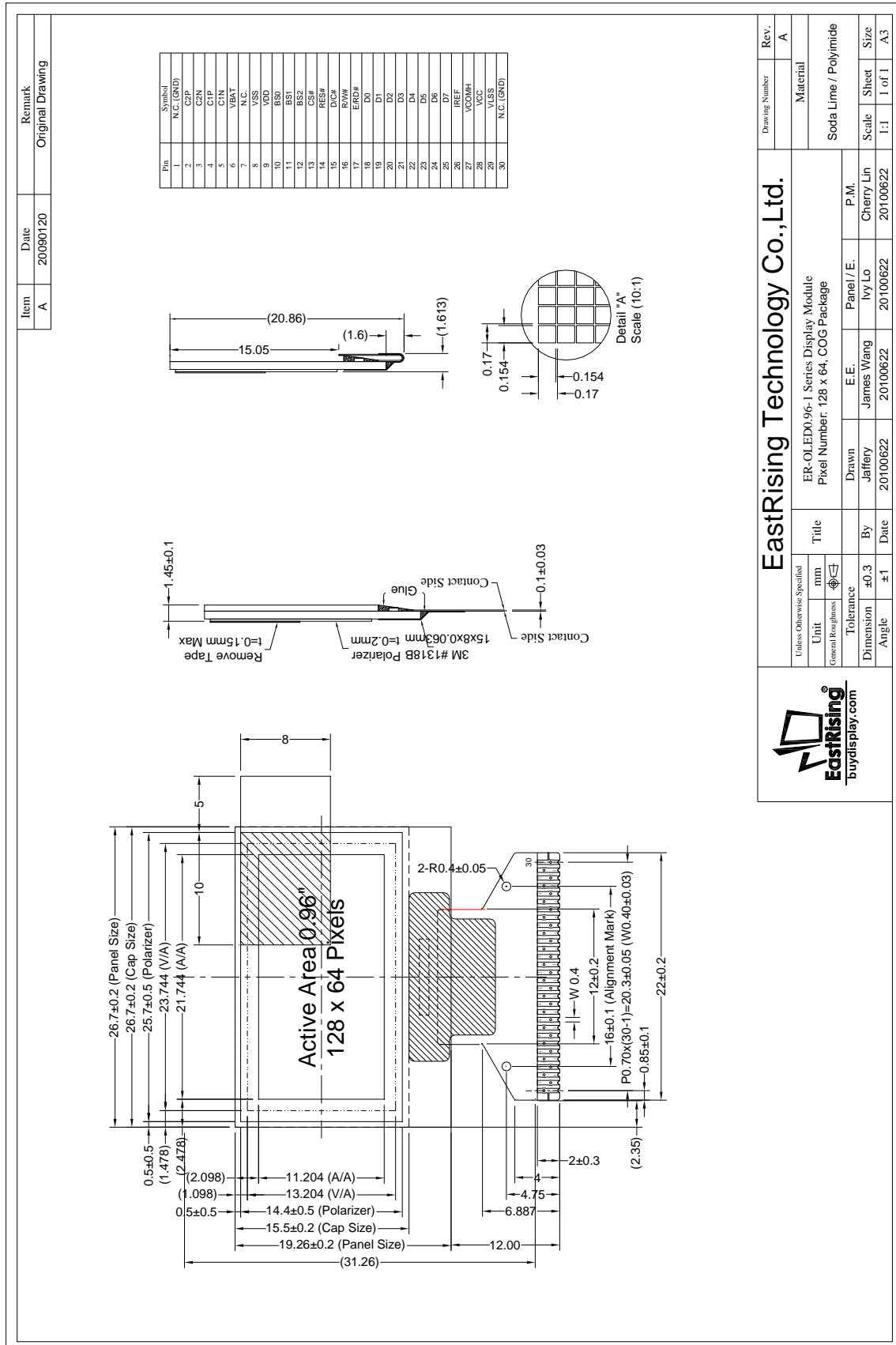

1.4.1 Mechanical Drawing (with Connector Type FPC Bottom Contact)

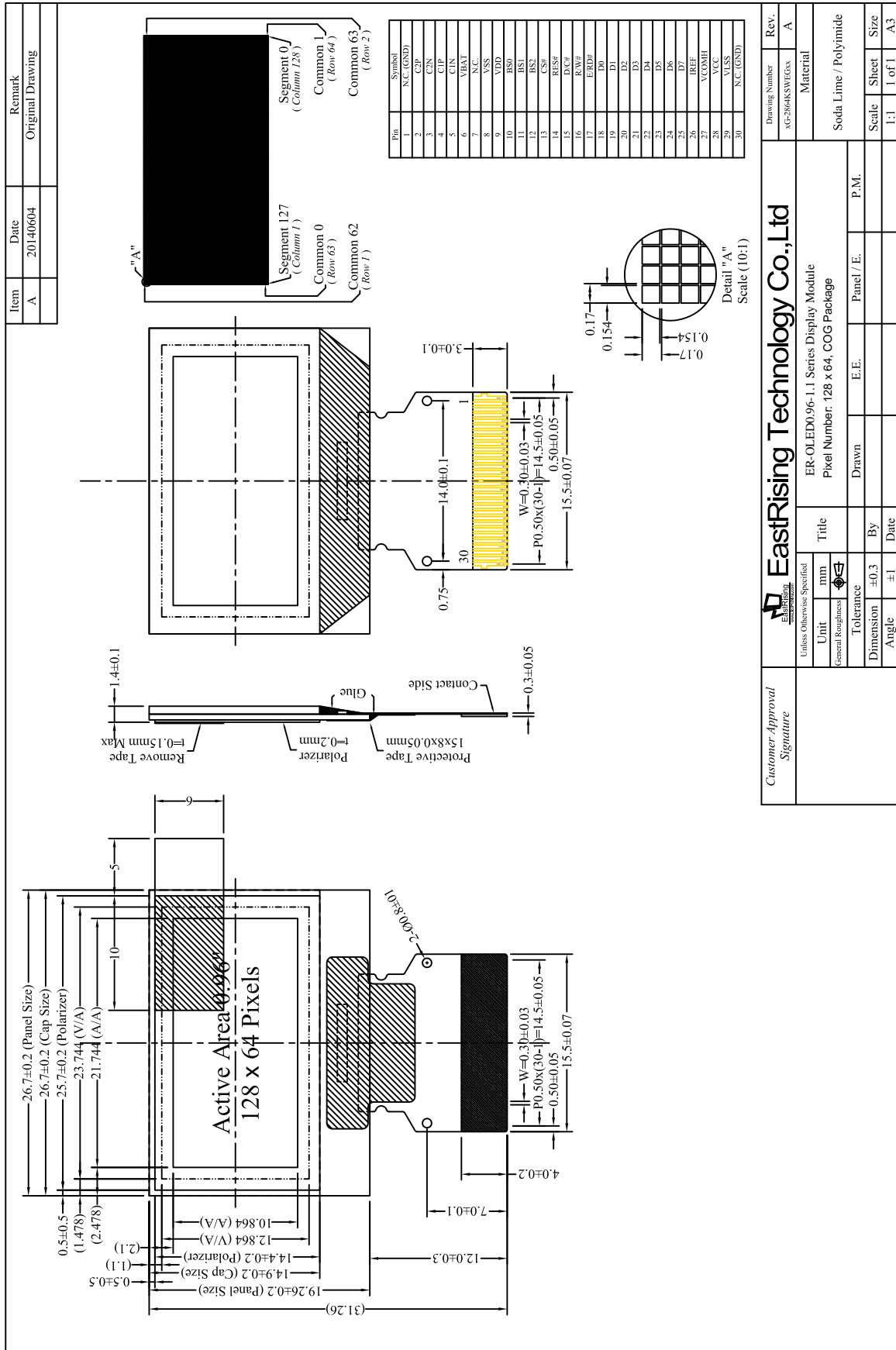

Customer Approval Signature		EastRising Technology Co., Ltd		Drawing Number		Rev.
		ER-OLED0.96-1.1 Series Display Module		SG-2864KSWFG0A		A
Title		Pixel Number: 128 x 64, COG Package		Material		
Unit		mm		Soda Lime / Polyimide		
General Roughness		E.E.		Scale		1:1
Tolerance		±0.3		Sheet		1 of 1
Dimension		±1		Size		A3
Angle				Date		
Signature		Date		Panel / E.		P.M.
By				Drawn		
Date				E.E.		

1.4.2 Mechanical Drawing (with Connector Type FPC Top Contact)

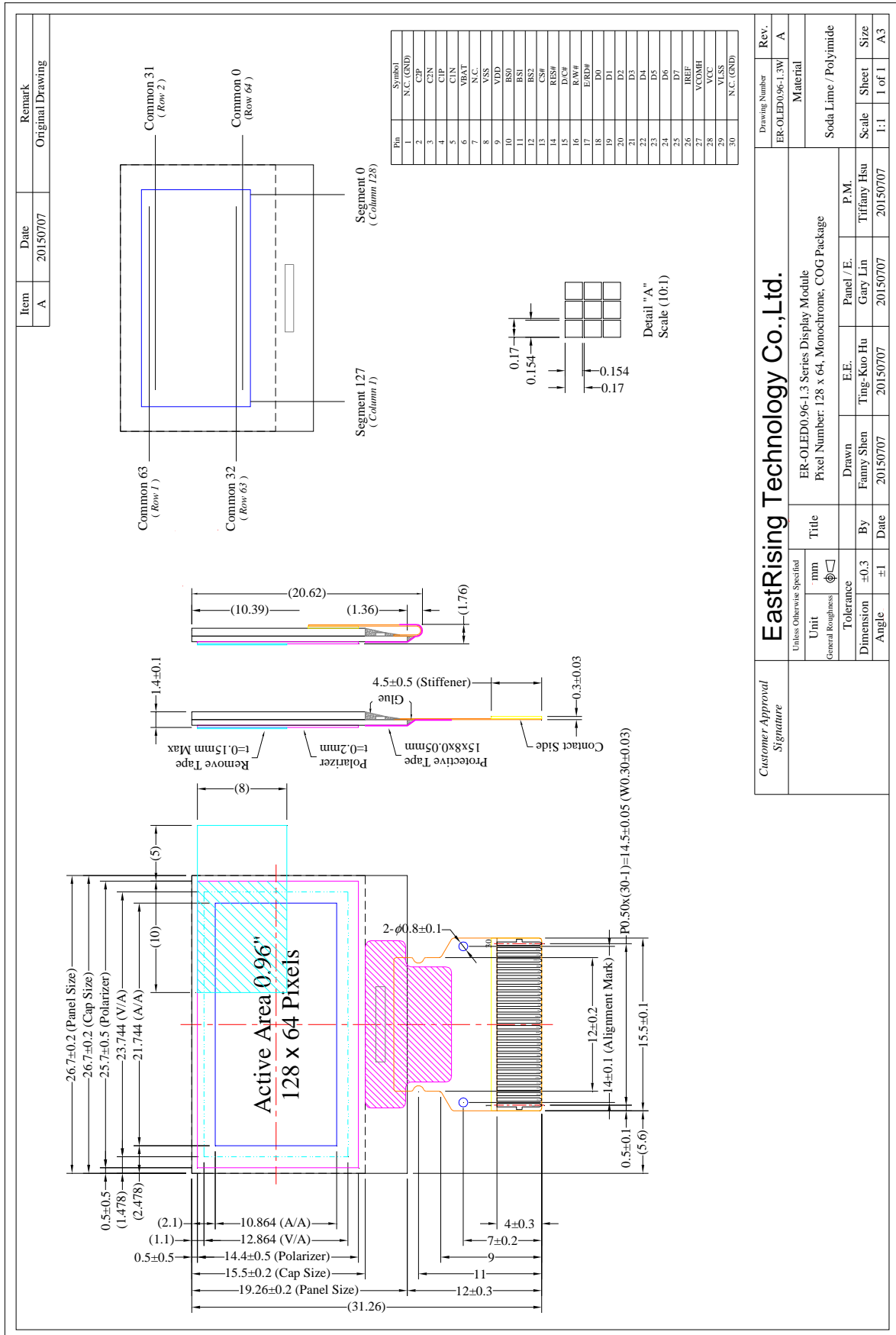

1.5 Pin Definition

Pin Number	Symbol	Type	Function																								
Power Supply																											
9	VDD	P	Power Supply for Logic This is a voltage supply pin. It must be connected to external source.																								
8	VSS	P	Ground of Logic Circuit This is a ground pin. It acts as a reference for the logic pins. It must be connected to external ground.																								
28	VCC	P	Power Supply for OEL Panel This is the most positive voltage supply pin of the chip. A stabilization capacitor should be connected between this pin and VSS when the converter is used. It must be connected to external source when the converter is not used.																								
29	VLSS	P	Ground of Analog Circuit This is an analog ground pin. It should be connected to VSS externally.																								
Driver																											
26	IREF	I	Current Reference for Brightness Adjustment This pin is segment current reference pin. A resistor should be connected between this pin and VSS. Set the current lower than 12.5μA.																								
27	VCOMH	O	Voltage Output High Level for COM Signal This pin is the input pin for the voltage output high level for COM signals. A capacitor should be connected between this pin and VSS.																								
DC/DC Converter																											
6	VBAT	P	Power Supply for DC/DC Converter Circuit This is the power supply pin for the internal buffer of the DC/DC voltage converter. It must be connected to external source when the converter is used. It should be connected to VDD when the converter is not used.																								
4 / 5 2 / 3	C1P / C1N C2P / C2N	I	Positive Terminal of the Flying Inverting Capacitor Negative Terminal of the Flying Boost Capacitor The charge-pump capacitors are required between the terminals. They must be floated when the converter is not used.																								
Interface																											
10 11 12	BS0 BS1 BS2	I	Communicating Protocol Select These pins are MCU interface selection input. See the following table: <table border="1" style="margin-left: 20px;"> <thead> <tr> <th></th> <th>BS0</th> <th>BS1</th> <th>BS2</th> </tr> </thead> <tbody> <tr> <td>I2C</td> <td>0</td> <td>1</td> <td>0</td> </tr> <tr> <td>3-wire SPI</td> <td>1</td> <td>0</td> <td>0</td> </tr> <tr> <td>4-wire SPI</td> <td>0</td> <td>0</td> <td>0</td> </tr> <tr> <td>8-bit 68XX Parallel</td> <td>0</td> <td>0</td> <td>1</td> </tr> <tr> <td>8-bit 80XX Parallel</td> <td>0</td> <td>1</td> <td>1</td> </tr> </tbody> </table>		BS0	BS1	BS2	I2C	0	1	0	3-wire SPI	1	0	0	4-wire SPI	0	0	0	8-bit 68XX Parallel	0	0	1	8-bit 80XX Parallel	0	1	1
	BS0	BS1	BS2																								
I2C	0	1	0																								
3-wire SPI	1	0	0																								
4-wire SPI	0	0	0																								
8-bit 68XX Parallel	0	0	1																								
8-bit 80XX Parallel	0	1	1																								
14	RES#	I	Power Reset for Controller and Driver This pin is reset signal input. When the pin is low, initialization of the chip is executed.																								

1.5 Pin Definition (Continued)

Pin Number	Symbol	I/O	Function
Interface (Continued)			
13	CS#	I	Chip Select This pin is the chip select input. The chip is enabled for MCU communication only when CS# is pulled low.
15	D/C#	I	Data/Command Control This pin is Data/Command control pin. When the pin is pulled high, the input at D7~D0 is treated as display data. When the pin is pulled low, the input at D7~D0 will be transferred to the command register. For detail relationship to MCU interface signals, please refer to the Timing Characteristics Diagrams. When the pin is pulled high and serial interface mode is selected, the data at SDIN is treated as data. When it is pulled low, the data at SDIN will be transferred to the command register. In I2C mode, this pin acts as SA0 for slave address selection.
17	E/RD#	I	Read/Write Enable or Read This pin is MCU interface input. When interfacing to a 68XX-series microprocessor, this pin will be used as the Enable (E) signal. Read/write operation is initiated when this pin is pulled high and the CS# is pulled low. When connecting to an 80XX-microprocessor, this pin receives the Read (RD#) signal. Data read operation is initiated when this pin is pulled low and CS# is pulled low.
16	R/W#	I	Read/Write Select or Write This pin is MCU interface input. When interfacing to a 68XX-series microprocessor, this pin will be used as Read/Write (R/W#) selection input. Pull this pin to "High" for read mode and pull it to "Low" for write mode. When 80XX interface mode is selected, this pin will be the Write (WR#) input. Data write operation is initiated when this pin is pulled low and the CS# is pulled low.
18~25	D0~D7	I/O	Host Data Input/Output Bus These pins are 8-bit bi-directional data bus to be connected to the microprocessor's data bus. When serial mode is selected, D1 will be the serial data input SDIN and D0 will be the serial clock input SCLK. When I2C mode is selected, D2 & D1 should be tied together and serve as SDAout & SDAin in application and D0 is the serial clock input SCL.
Reserve			
7	N.C.	-	Reserved Pin The N.C. pins between function pins are reserved for compatible and flexible design.
1, 30	N.C. (GND)	-	Reserved Pin (Supporting Pin) The supporting pins can reduce the influences from stresses on the function pins. These pins must be connected to external ground.

1.6 Block Diagram

1.6.1 V_{CC} Supplied Externally

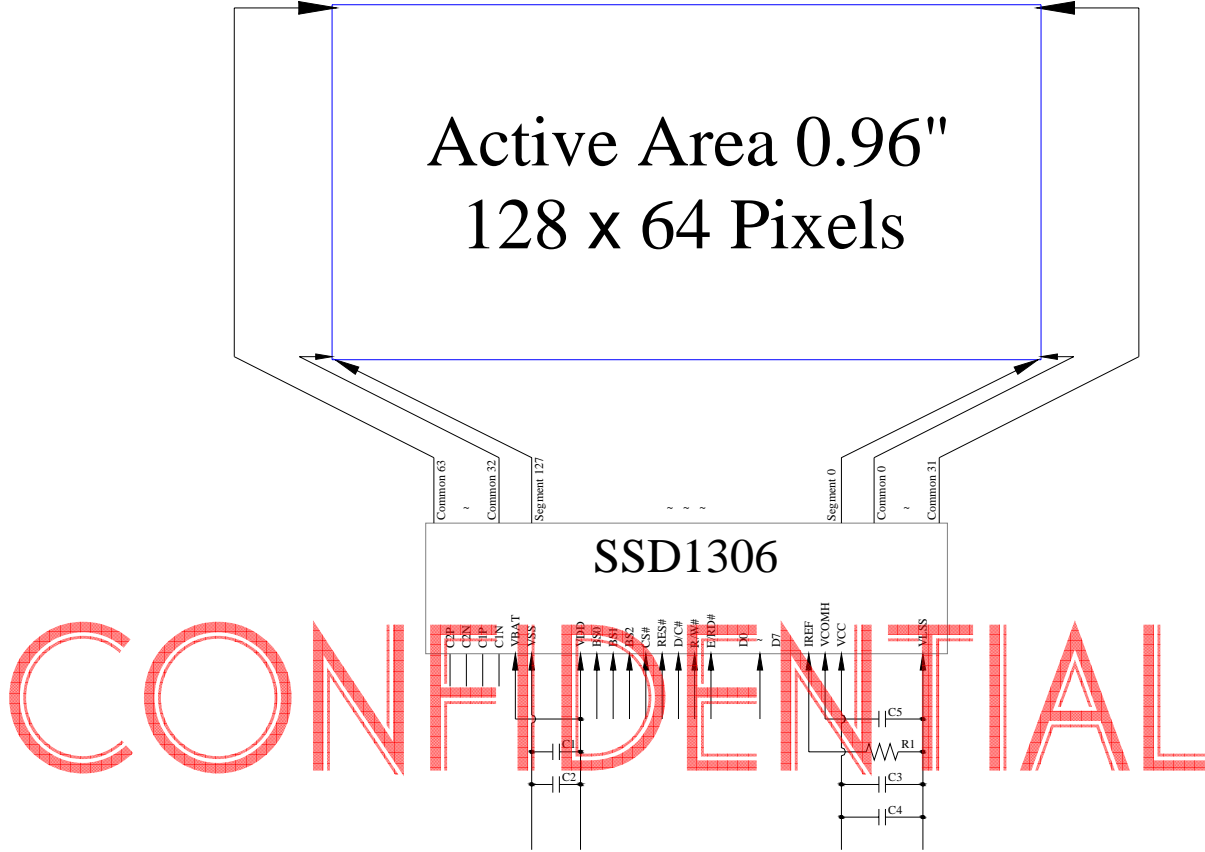

MCU Interface Selection: BS0, BS1 and BS2
 Pins connected to MCU interface: CS#, RES#, D/C#, R/W#, E/RD#, and D0~D7

C1, C3: 0.1μF
 C2, C4: 2.2μF
 C5: 4.7μF X7R
 R1: 560kΩ, R1 = (Voltage at IREF – VSS) / IREF

1.6.2 V_{CC} Generated by Internal DC/DC Circuit

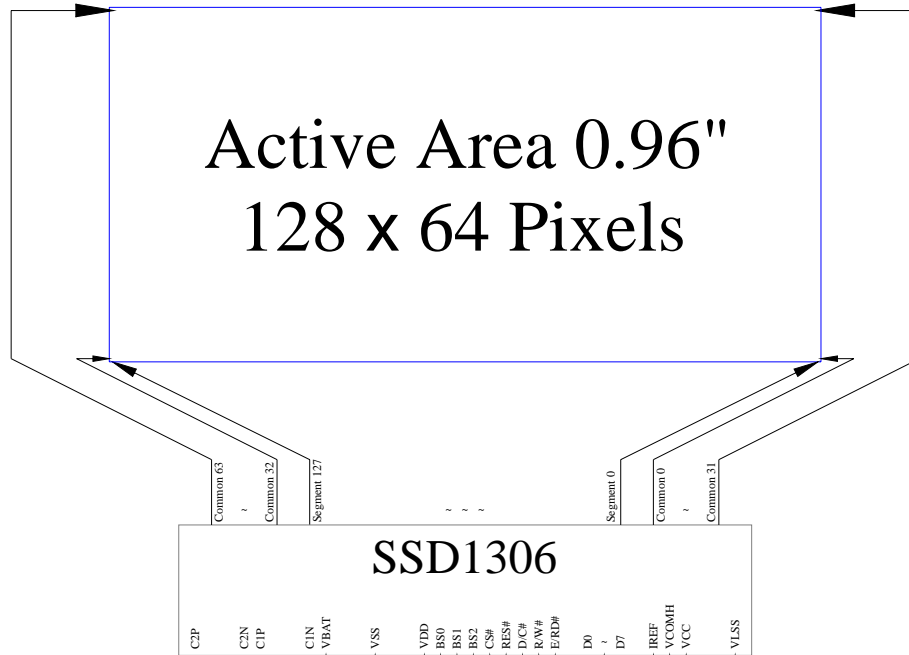

CONFIDENTIAL

MCU Interface Selection: BS0, BS1 and BS2
 Pins connected to MCU interface: CS#, RES#, D/C#, R/W#, E/RD#, and D0~D7

- C1, C2, C5, C6: 1μF
- C3: 2.2μF
- C4: 4.7μF X7R
- R1: 390kΩ, R1 = (Voltage at IREF – VSS) / IREF

2. Absolute Maximum Ratings

Parameter	Symbol	Min	Max	Unit	Notes
Supply Voltage for Logic	V _{DD}	-0.3	4	V	1, 2
Supply Voltage for Display	V _{CC}	0	11	V	1, 2
<i>Supply Voltage for DC/DC</i>	<i>V_{BAT}</i>	<i>-0.3</i>	<i>5</i>	<i>V</i>	<i>1, 2</i>
Operating Temperature	T _{OP}	-30	70	°C	-
Storage Temperature	T _{STG}	-40	80	°C	-

Note 1: All the above voltages are on the basis of “VSS = 0V”.

Note 2: When this module is used beyond the above absolute maximum ratings, permanent breakage of the module may occur. Also, for normal operations, it is desirable to use this module under the conditions according to Section 3. “Optics & Electrical Characteristics”. If this module is used beyond these conditions, malfunctioning of the module can occur and the reliability of the module may deteriorate.

3. Optics & Electrical Characteristics

3.1 Optics Characteristics

Characteristics	Symbol	Conditions	Min	Typ	Max	Unit
Brightness (V _{CC} Supplied Externally)	L _{br}	With Polarizer (Note 3)	100	120	-	cd/m ²
<i>Brightness</i> (V _{CC} Generated by Internal DC/DC)	<i>L_{br}</i>	<i>With Polarizer</i> (Note 4)	<i>80</i>	<i>100</i>	-	<i>cd/m²</i>
C.I.E.	(x) (y)	Without Polarizer	0.12 0.22	0.16 0.26	0.20 0.30	
Dark Room Contrast	CR		-	>2000:1	-	
View Angle			>160	-	-	degree

* Optical measurement taken at V_{DD} = 2.8V, V_{CC} = 9V & 7.25V.
Software configuration follows Section 4.4 Initialization.

3.2 DC Characteristics

Characteristics	Symbol	Conditions	Min	Typ	Max	Unit
Supply Voltage for Logic	V _{DD}		1.65	2.8	3.3	V
Supply Voltage for Display (Supplied Externally)	V _{CC}	Note 3	8.5	9	9.5	V
<i>Supply Voltage for DC/DC</i>	<i>V_{BAT}</i>	<i>Internal DC/DC Enable</i>	<i>3.5</i>	-	<i>4.2</i>	<i>V</i>
<i>Supply Voltage for Display</i> (Generated by Internal DC/DC)	<i>V_{CC}</i>	<i>Note 4</i>	<i>7</i>	<i>7.25</i>	<i>7.5</i>	<i>V</i>
High Level Input	V _{IH}	-	0.8×V _{DD}	-	V _{DD}	V
Low Level Input	V _{IL}	-	0	-	0.2×V _{DD}	V
High Level Output	V _{OH}	I _{OUT} = 100μA, 3.3MHz	0.9×V _{DD}	-	V _{DD}	V
Low Level Output	V _{OL}	I _{OUT} = 100μA, 3.3MHz	0	-	0.1×V _{DD}	V
Operating Current for V _{DD}	I _{DD}	-	-	180	300	μA
Operating Current for V _{CC} (V _{CC} Supplied Externally)	I _{CC}	Note 5	-	7.3	9.1	mA
		Note 6	-	12.3	15.4	mA
<i>Operating Current for V_{BAT}</i> (V _{CC} Generated by Internal DC/DC)	<i>I_{BAT}</i>	<i>Note 7</i>	-	<i>18.8</i>	<i>23.5</i>	<i>mA</i>
		<i>Note 8</i>	-	<i>25.6</i>	<i>32.0</i>	<i>mA</i>
Sleep Mode Current for V _{DD}	I _{DD, SLEEP}	-	-	1	5	μA
Sleep Mode Current for V _{CC}	I _{CC, SLEEP}	-	-	1	5	μA

Note 3 & 4: Brightness (L_{br}) and Supply Voltage for Display (V_{CC}) are subject to the change of the panel characteristics and the customer's request.

Note 5: V_{DD} = 2.8V, V_{CC} = 9V, 50% Display Area Turn on.

Note 6: V_{DD} = 2.8V, V_{CC} = 9V, 100% Display Area Turn on.

Note 7: V_{DD} = 2.8V, V_{CC} = 7.25V, 50% Display Area Turn on.

Note 8: V_{DD} = 2.8V, V_{CC} = 7.25V, 100% Display Area Turn on.

3.3 AC Characteristics

3.3.1 68XX-Series MPU Parallel Interface Timing Characteristics:

Symbol	Description	Min	Max	Unit
t_{cycle}	Clock Cycle Time	300	-	ns
t_{AS}	Address Setup Time	0	-	ns
t_{AH}	Address Hold Time	0	-	ns
t_{DSW}	Write Data Setup Time	40	-	ns
t_{DHW}	Write Data Hold Time	7	-	ns
t_{DHR}	Read Data Hold Time	20	-	ns
t_{OH}	Output Disable Time	-	70	ns
t_{ACC}	Access Time	-	140	ns
PW_{CSL}	Chip Select Low Pulse Width (Read)	120	-	ns
	Chip Select Low Pulse width (Write)	60	-	ns
PW_{CSH}	Chip Select High Pulse Width (Read)	60	-	ns
	Chip Select High Pulse Width (Write)	60	-	ns
t_R	Rise Time	-	40	ns
t_F	Fall Time	-	40	ns

* ($V_{DD} - V_{SS} = 1.65V$ to $3.3V$, $T_a = 25^\circ C$)

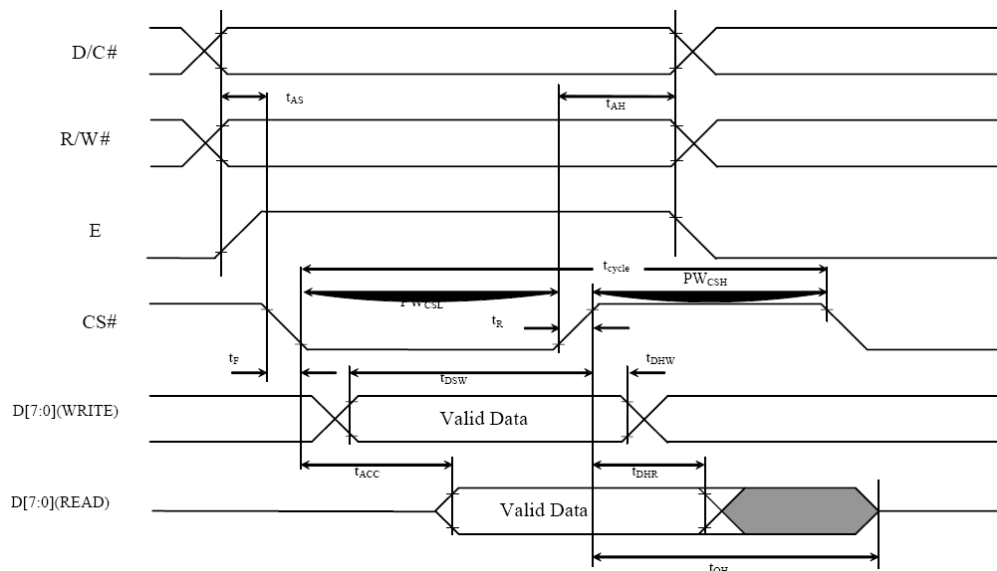

3.3.2 80XX-Series MPU Parallel Interface Timing Characteristics:

Symbol	Description	Min	Max	Unit
t_{cycle}	Clock Cycle Time	300	-	ns
t_{AS}	Address Setup Time	10	-	ns
t_{AH}	Address Hold Time	0	-	ns
t_{DSW}	Write Data Setup Time	40	-	ns
t_{DHW}	Write Data Hold Time	7	-	ns
t_{DHR}	Read Data Hold Time	20	-	ns
t_{OH}	Output Disable Time	-	70	ns
t_{ACC}	Access Time	-	140	ns
t_{PWLR}	Read Low Time	120	-	ns
t_{PWLW}	Write Low Time	60	-	ns
t_{PWHR}	Read High Time	60	-	ns
t_{PWHW}	Write High Time	60	-	ns
t_{CS}	Chip Select Setup Time	0	-	ns
t_{CSH}	Chip Select Hold Time to Read Signal	0	-	ns
t_{CSF}	Chip Select Hold Time	20	-	ns
t_R	Rise Time	-	40	ns
t_F	Fall Time	-	40	ns

* ($V_{DD} - V_{SS} = 1.65V$ to $3.3V$, $T_a = 25^\circ C$)

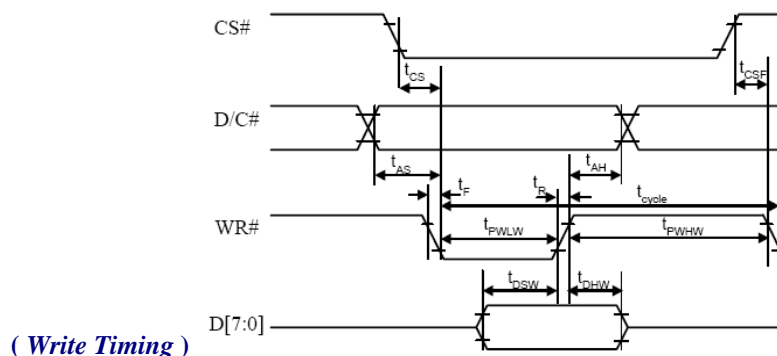
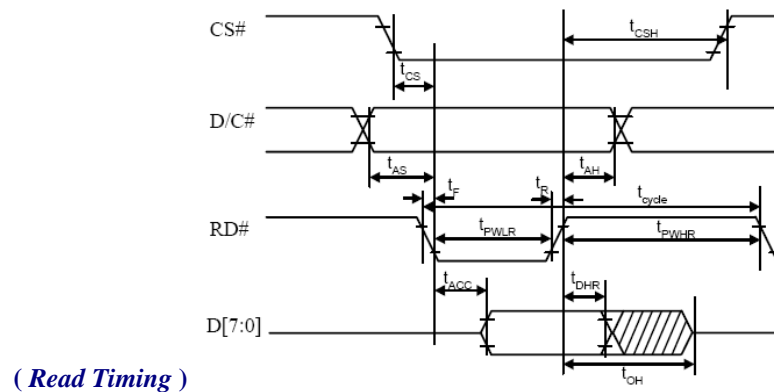

3.3.3 Serial Interface Timing Characteristics: (4-wire SPI)

Symbol	Description	Min	Max	Unit
t_{cycle}	Clock Cycle Time	100	-	ns
t_{AS}	Address Setup Time	15	-	ns
t_{AH}	Address Hold Time	15	-	ns
t_{CSS}	Chip Select Setup Time	20	-	ns
t_{CSH}	Chip Select Hold Time	10	-	ns
t_{DSW}	Write Data Setup Time	15	-	ns
t_{DHW}	Write Data Hold Time	15	-	ns
t_{CLKL}	Clock Low Time	20	-	ns
t_{CLKH}	Clock High Time	20	-	ns
t_R	Rise Time	-	40	ns
t_F	Fall Time	-	40	ns

* ($V_{DD} - V_{SS} = 1.65V$ to $3.3V$, $T_a = 25^\circ C$)

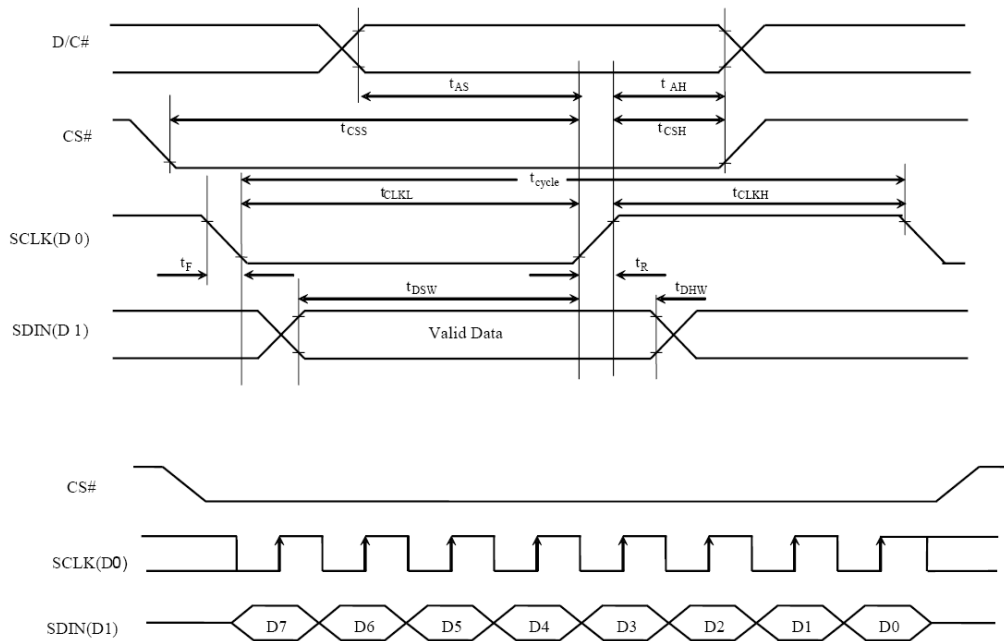

3.3.4 Serial Interface Timing Characteristics: (3-wire SPI)

Symbol	Description	Min	Max	Unit
t_{cycle}	Clock Cycle Time	100	-	ns
t_{CSS}	Chip Select Setup Time	20	-	ns
t_{CSH}	Chip Select Hold Time	10	-	ns
t_{DSW}	Write Data Setup Time	15	-	ns
t_{DHW}	Write Data Hold Time	15	-	ns
t_{CLKL}	Clock Low Time	20	-	ns
t_{CLKH}	Clock High Time	20	-	ns
t_R	Rise Time	-	40	ns
t_F	Fall Time	-	40	ns

* ($V_{DD} - V_{SS} = 1.65V$ to $3.3V$, $T_a = 25^\circ C$)

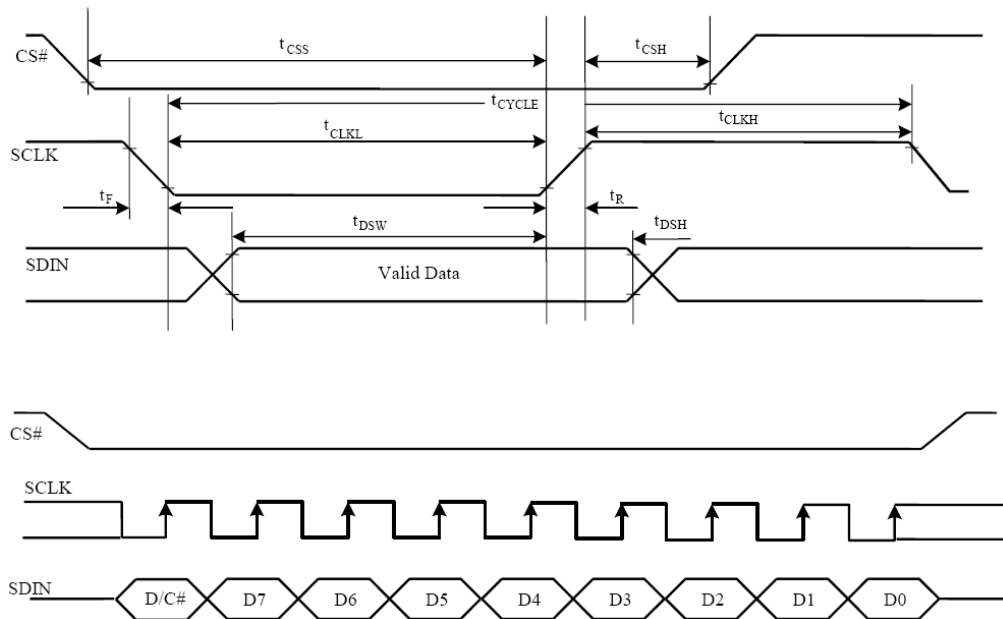

3.3.5 I²C Interface Timing Characteristics:

Symbol	Description	Min	Max	Unit
t _{cycle}	Clock Cycle Time	2.5	-	us
t _{HSTART}	Start Condition Hold Time	0.6	-	us
t _{HD}	Data Hold Time (for “SDA _{OUT} ” Pin)	0	-	ns
	Data Hold Time (for “SDA _{IN} ” Pin)	300		
t _{SD}	Data Setup Time	100	-	ns
t _{SSTART}	Start Condition Setup Time (Only relevant for a repeated Start condition)	0.6	-	us
t _{SSTOP}	Stop Condition Setup Time	0.6	-	us
t _R	Rise Time for Data and Clock Pin		300	ns
t _F	Fall Time for Data and Clock Pin		300	ns
t _{IDLE}	Idle Time before a New Transmission can Start	1.3	-	us

* (V_{DD} - V_{SS} = 1.65V to 3.3V, T_a = 25°C)

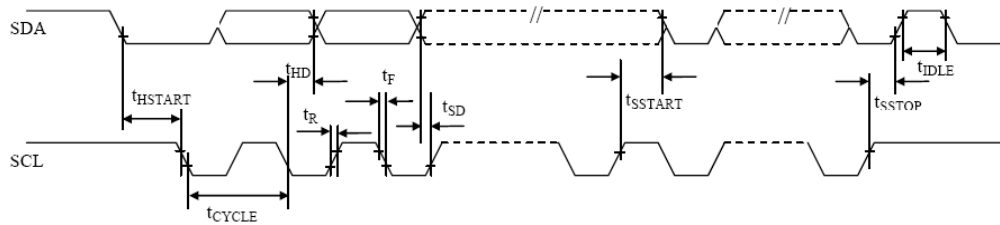

4. Functional Specification

4.1. Commands

Refer to the Technical Manual for the SSD1306

4.2 Power down and Power up Sequence

To protect OEL panel and extend the panel life time, the driver IC power up/down routine should include a delay period between high voltage and low voltage power sources during turn on/off. It gives the OEL panel enough time to complete the action of charge and discharge before/after the operation.

4.2.1 Power up Sequence:

1. Power up V_{DD}
2. Send Display off command
3. Initialization
4. Clear Screen
5. Power up V_{CC}
6. Delay 100ms
(When V_{CC} is stable)
7. Send Display on command

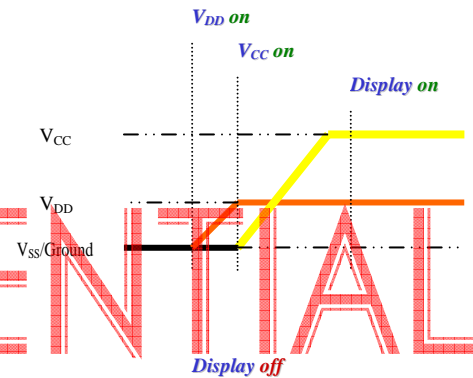

4.2.2 Power down Sequence:

1. Send Display off command
2. Power down V_{CC}
3. Delay 100ms
(When V_{CC} is reach 0 and panel is completely discharges)
4. Power down V_{DD}

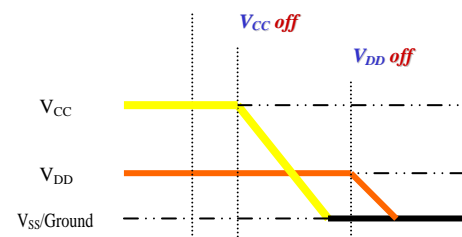

4.3 Reset Circuit

When RES# input is low, the chip is initialized with the following status:

1. Display is OFF
2. 128×64 Display Mode
3. Normal segment and display data column and row address mapping (SEG0 mapped to column address 00h and COM0 mapped to row address 00h)
4. Shift register data clear in serial interface
5. Display start line is set at display RAM address 0
6. Column address counter is set at 0
7. Normal scan direction of the COM outputs
8. Contrast control register is set at 7Fh
9. Normal display mode (Equivalent to A4h command)

4.4 Actual Application Example

Command usage and explanation of an actual example

<Initialization>

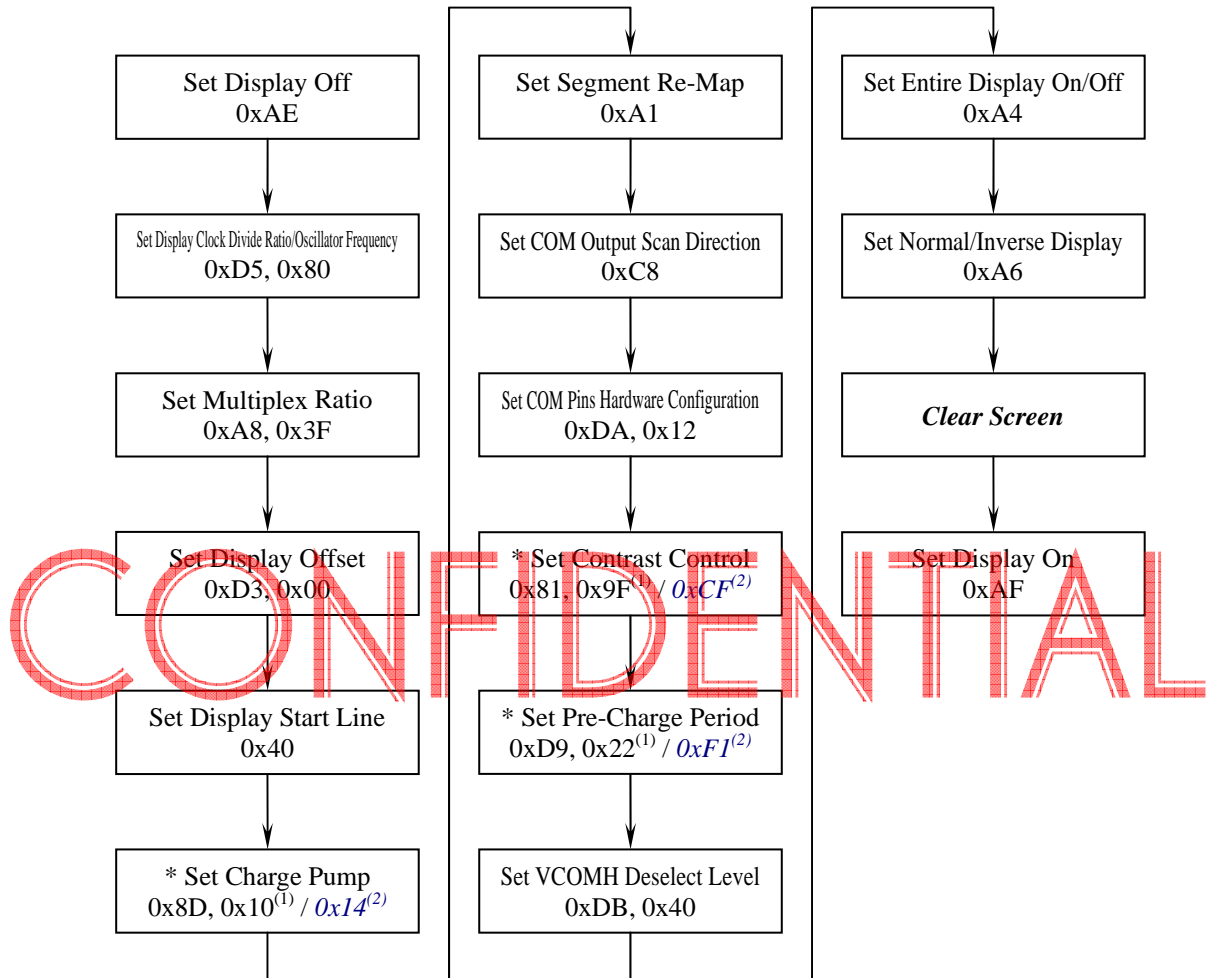

* Written Value for Parameters

⁽¹⁾ → V_{CC} Supplied Externally

⁽²⁾ → V_{CC} Generated by Internal DC/DC Circuit

If the noise is accidentally occurred at the displaying window during the operation, please reset the display in order to recover the display function.

5. Reliability

5.1 Contents of Reliability Tests

Item	Conditions	Criteria
High Temperature Operation	70°C, 240 hrs	The operational functions work.
Low Temperature Operation	-30°C, 240 hrs	
High Temperature Storage	80°C, 240 hrs	
Low Temperature Storage	-40°C, 240 hrs	
High Temperature/Humidity Operation	60°C, 90% RH, 120 hrs	
Thermal Shock	-40°C ↔ 85°C, 24 cycles 60 mins dwell	

* The samples used for the above tests do not include polarizer.

* No moisture condensation is observed during tests.

5.2 Lifetime

End of lifetime is specified as 50% of initial brightness reached.

Parameter	Min	Max	Unit	Condition	Notes
Operating Life Time	10,000	-	hr	100 cd/m ² , 50% Checkerboard	6
Storage Life Time	20,000	-	hr	T _a = 25°C, 50% RH	-

Note 6: The average operating lifetime at room temperature is estimated by the accelerated operation at high temperature conditions.

5.3 Failure Check Standard

After the completion of the described reliability test, the samples were left at room temperature for 2 hrs prior to conducting the failure test at 23±5°C; 55±15% RH.

6. QUALITY CONTROL

6.1 EastRising Environment Required

Customer's test & measurement are required to be conducted under the following conditions:

Temperature:	23±5℃
Humidity:	55±15% RH
Fluorescent Lamp:	30W
Distance between the Panel & Lamp:	≥50cm
Distance between the Panel & Eyes of the Inspector:	≥30cm

Finger glove (or finger cover) must be worn by the inspector.
Inspection table of jig must be anti-electrostatic.



6.2 EastRising OLED Display Criteria & Acceptable Quality Level

Partition	AQL	Definition
Major	0.65	Defects in Pattern Check (Display On)
Minor	1.0	Defects in Cosmetic Check (Display Off)

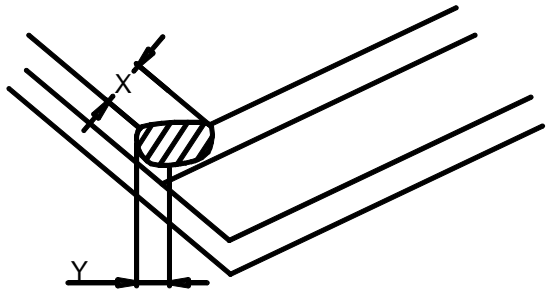
6.2.1 EastRising Cosmetic Check (Display Off) in Non-Active Area

Check Item	Classification	Criteria
Panel General Chipping	Minor	<p>X>6mm (Along with Edge) Y>1mm (Perpendicular to edge)</p> 

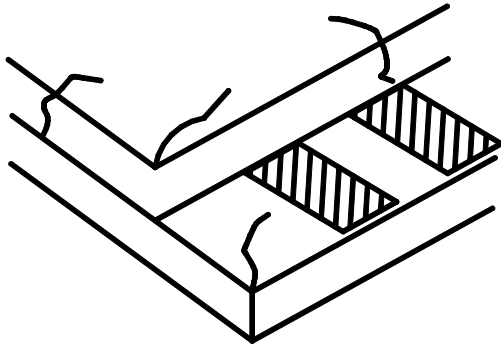
6.2.2 EastRising Cosmetic Check (Display Off)in Non-Active Area (Continued)

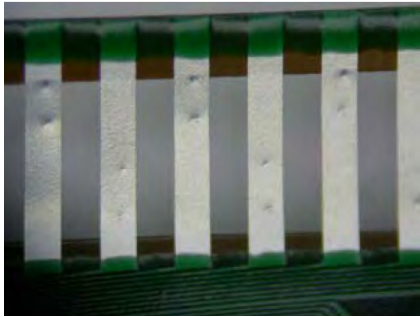
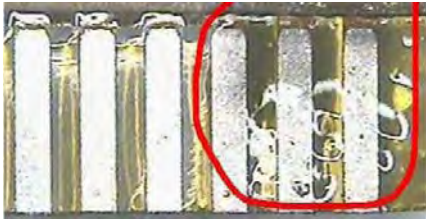
Check Item	Classification	Criteria
Panel Crack	Minor	Any crack is not allowable 
Copper Exposed (Even Pin or Film)	Minor	Not Allowable by Naked Eye Inspection
Film or Trace Damage	Minor	
Terminal Lead Prober Mark	Acceptable	
Glue or Contamination on Pin	Minor	
Ink marking on Back Side of Panel (Exclude on Film)	Acceptable	Ignore for Any

6.2.3 EastRising Cosmetic Check (Display Off) in Active Area

EastRising recommends to execute in clear environment (class 10k) if actual in necessary.

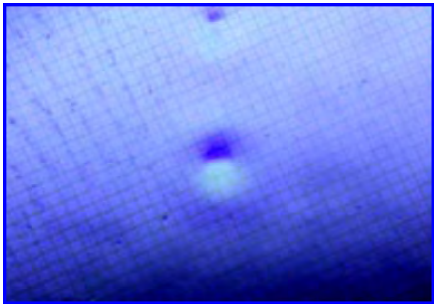
Check Item	Classification	Criteria
Any Dirt & Scratch on Polarizer's Protective Film	Acceptable	Ignore for not Affect the Polarizer
Scratches,Fiber,Line-Shape Defect (On Polarizer)	Minor	$W \leq 0.1$ Ignore $W > 0.1$ $L \leq 2$ $n \leq 1$ $L > 2$ $n = 0$
Dirt, Black Spot, Foreign Material (On Polarizer)	Minor	$\Phi \leq 0.1$ Ignore $0.1 < \Phi \leq 0.25$ $n \leq 1$ $0.25 < \Phi$ $n = 0$
Dent,Bubbles,White Spot (Any Transparent Spot on Polarizer)	Minor	$\Phi \leq 0.5$ Ignore if no Influence on Display $0.5 < \Phi$ $n = 0$ 
Fingerprint ,Flow Mark (On Polarizer)	Minor	Not Allowable

* Protective film should not be tear off when cosmetic check.

* Definition of W & L & Φ (Unit:mm): $\Phi = (a+b)/2$

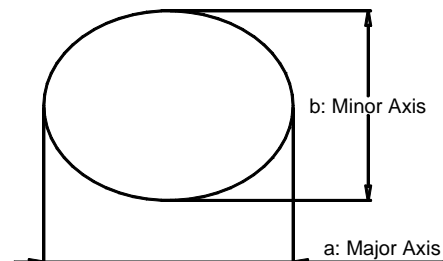
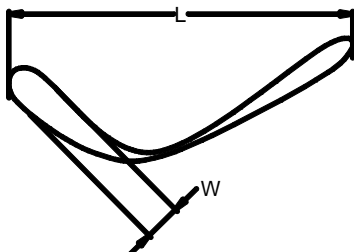

6.2.4 EastRising Pattern Check (Display On) in Active Area

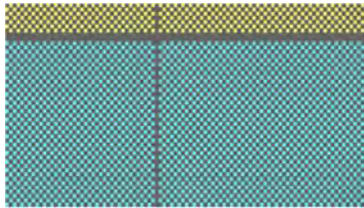
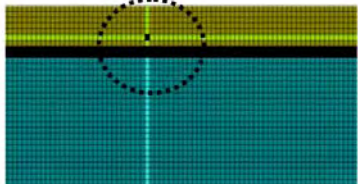
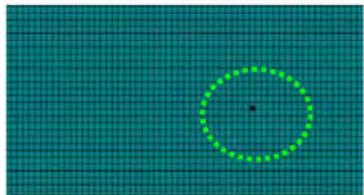
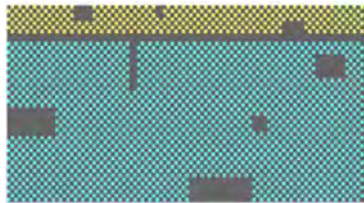
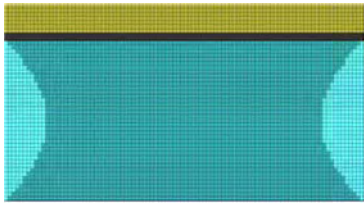
Check Item	Classification	Criteria
No Display	Major	
Missing Line	Major	
Pixel Short	Major	
Darker Pixel	Major	
Wrong Display	Major	
Un-uniform	Major	

7.PRECAUTIONS for USING

7.1 Handling Precautions

- 1) Since the EastRising OLED display panel is being made of glass, do not apply mechanical impacts such as dropping from a high position.
- 2) If the display panel is broken by some accident and the internal organic substance leaks out, be careful not to inhale nor lick the organic substance.
- 3) If pressure is applied to the display surface or its neighborhood of the EastRising OLED display module, the cell structure may be damaged and be careful not to apply pressure to these sections.
- 4) The polarizer covering the surface of the OLED display module is soft and easily scratched. Please be careful when handling the OLED display module.
- 5) When the surface of the polarizer of the OLED display module has soil, clean the surface. It takes advantage of by using following adhesion tape.
 - * Scotch Mending Tape No. 810 or an equivalentNever try to breathe upon the soiled surface nor wipe the surface using cloth containing solvent such as ethyl alcohol, since the surface of the polarizer will become cloudy. Also, pay attention that the following liquid and solvent may spoil the polarizer:
 - * Water
 - * Ketone
 - * Aromatic Solvents
- 6) Hold EastRising OLED display module very carefully when placing OLED display module into the system housing. Do not apply excessive stress or pressure to OLED display module. And, do not over bend the film with electrode pattern layouts. These stresses will influence the display performance. Also, secure sufficient rigidity for the outer cases.
- 7) Do not apply stress to the driver IC and the surrounding molded sections.
- 8) Do not disassemble nor modify the OLED display module.
- 9) Do not apply input signals while the logic power is off.
- 10) Pay sufficient attention to the working environments when handling EastRising OLED display modules to prevent occurrence of element breakage accidents by static electricity.
 - * Be sure to make human body grounding when handling OLED display modules.
 - * Be sure to ground tools to use or assembly such as soldering irons.
 - * To suppress generation of static electricity, avoid carrying out assembly work under dry environments.

* Protective film is being applied to the surface of the display panel of the OLED display module.
Be careful since static electricity may be generated when exfoliating the protective film.

11) Protection film is being applied to the surface of the display panel and removes the protection film before assembling it. At this time, if the EastRising OLED display module has been stored for a long period of time, residue adhesive material of the protection film may remain on the surface of the display panel after removed of the film. In such case, remove the residue material by the method introduced in the above Section 5).

12) If electric current is applied when the OLED display module is being dewed or when it is placed under high humidity environments, the electrodes may be corroded and be careful to avoid the above.

7.2 Storage Precautions

- 1) When storing EastRising OLED display modules, put them in static electricity preventive bags avoiding exposure neither to direct sun light nor to lights of fluorescent lamps. and, also, avoiding high temperature and high humidity environment or low temperature (less than 0°C) environments. (We recommend you to store these modules in the packaged state when they were shipped from EastRising.) At that time, be careful not to let water drops adhere to the packages or bags nor let dewing occur with them.
- 2) If electric current is applied when water drops are adhering to the surface of the OLED display module, when the OLED display module is being dewed or when it is placed under high humidity environments, the electrodes may be corroded and be careful about the above.

7.3 Designing Precautions

- 1) The absolute maximum ratings are the ratings which cannot be exceeded for OLED display module, and if these values are exceeded, panel damage may be happen.
- 2) To prevent occurrence of malfunctioning by noise, pay attention to satisfy the VIL and VIH specifications and, at the same time, to make the signal line cable as short as possible.
- 3) We recommend you to install excess current preventive unit (fuses, etc.) to the power circuit (VDD). (Recommend value: 0.5A)
- 4) Pay sufficient attention to avoid occurrence of mutual noise interference with the neighboring devices.
- 5) As for EMI, take necessary measures on the equipment side basically.
- 6) When fastening the OLED display module, fasten the external plastic housing section.

7) If power supply to the EastRising OLED display module is forcibly shut down by such errors as taking out the main battery while the OLED display panel is in operation, we cannot guarantee the quality of this OLED display module.

7.4 Precautions when disposing of the EastRising OLED display modules

1) Request the qualified companies to handle industrial wastes when disposing of the OLED display modules. Or, when burning them, be sure to observe the environmental and hygienic laws and regulations.

7.5 Other Precautions

1) When an OLED display module is operated for a long of time with fixed pattern may remain as an after image or slight contrast deviation may occur. Nonetheless, if the operation is interrupted and left unused for a while, normal state can be restored. Also, there will be no problem in the reliability of the module.

2) To protect OLED display modules from performance drops by static electricity rapture, etc., do not touch the following sections whenever possible while handling the OLED display modules.

- * Pins and electrodes

- * Pattern layouts such as the FPC

3) With this OLED display module, the OLED driver is being exposed. Generally speaking, semiconductor elements change their characteristics when light is radiated according to the principle of the solar battery. Consequently, if this OLED driver is exposed to light, malfunctioning may occur.

- * Design the product and installation method so that the OLED driver may be shielded from light in actual usage.

- * Design the product and installation method so that the OLED driver may be shielded from light during the inspection processes.

4) Although this OLED display module stores the operation state data by the commands and the indication data, when excessive external noise, etc. enters into the module, the internal status may be changed. It therefore is necessary to take appropriate measures to suppress noise generation or to protect from influences of noise on the system design.

5) We recommend you to construct its software to make periodical refreshment of the operation statuses (re-setting of the commands and re-transference of the display data) to cope with catastrophic noise.

That's the end of the datasheet.